



**IMPORTANT - SAVE THESE
INSTRUCTIONS FOR FUTURE REFERENCE**

Reference Manual

Sorrento IP Double

UK & EUROPEAN MODELS:

SORD-020IP-SW, SORD-020IP-UK, SORD-020IP-EU	(2.0kW / 230V)
SORD-030IP-SW, SORD-030IP-UK, SORD-030IP-EU	(3.0kW / 230V)
SORD-040IP-SW, SORD-040IP-UK, SORD-040IP-EU	(4.0kW / 230V)

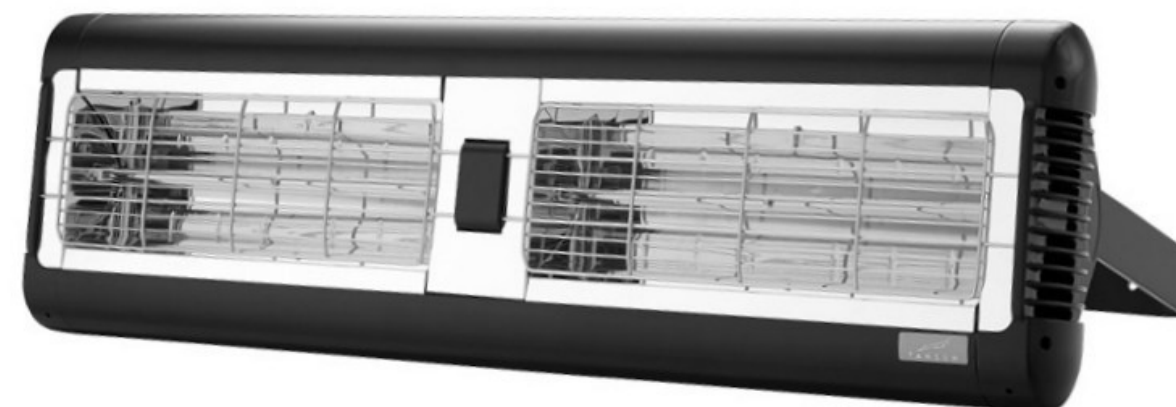
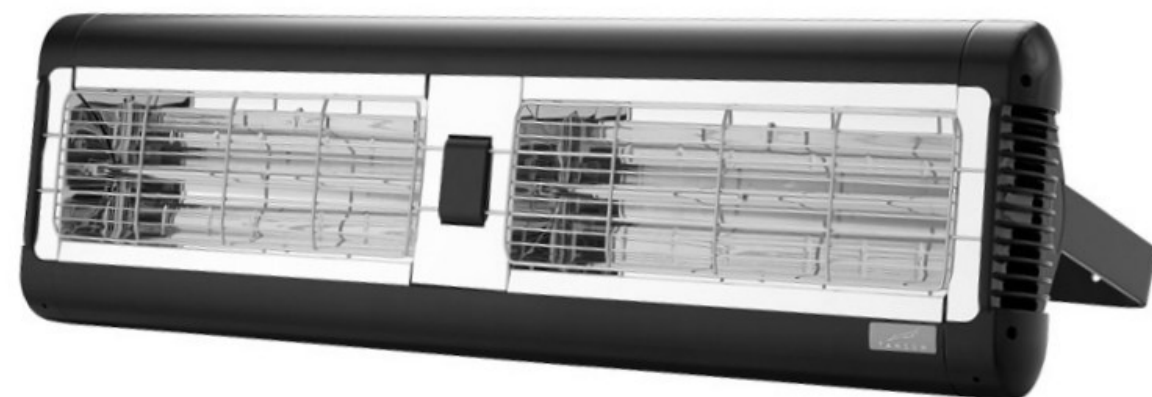

DECLARATION OF CONFORMITY

This product complies with the Harmonised European Standard: EN 60335-1:2012 in conjunction with EN 60335-2-30:2009 + A11 and EN 62233 and the European Standard Electromagnetic Compatibility EEC Directives 2004/108/EC and 89/336/EEC and the RoHS Directive 2011/65/EU



INFORMATION FOR EU-MEMBER STATES:

The use of this symbol indicates that this product may not be treated as household waste. By ensuring this product is disposed of correctly, you will help prevent potential negative consequences for the environment and human health, which could otherwise be caused by inappropriate waste handling of this product. For more detailed information about recycling of this product, please contact your local council, your household waste disposal service or the shop where you purchased the product.



SORRENTO IP HEATERS ARE DESIGNED AND MANUFACTURED FOR OUTDOOR USE. THEY CAN BE USED INDOORS BUT SHOULD BE USED IN CONJUNCTION WITH SUITABLE ENERGY SAVING CONTROLLERS TO COMPLY WITH EU 2015/118 (PLEASE CONTACT TANSUN FOR DETAILS)



TANSUN LIMITED

Spectrum House, Ridgacre Road, West Bromwich, West Midlands, B71 1BW, England
Tel: +44 (0)121 580 6200 - Fax: +44 (0)121 580 6222
Email: sales@tansun.com - Website: www.tansun.com

Due to our policy of ongoing improvement, we reserve the right to make changes without notice.

© 2018 TANSUN LIMITED

Ref No. 042221 Issue No. F

TANSUN LIMITED

Spectrum House, Ridgacre Road, West Bromwich,
West Midlands, B71 1BW, England

Tel: +44 (0)121 580 6200 - Fax: +44 (0)121 580 6222
Email: sales@tansun.com - Website: www.tansun.com

CAUTION

When using Tansun electrical heaters, basic precautions should always be followed to reduce the risk of fire, electric shock, and injury to persons, including the following:

Read all instructions before using this heater.

- Before using this appliance:
 - Check that the voltage indicated on the type plate corresponds to the mains supply voltage.
 - Ensure that the heater has been securely fastened in its final mounting position.
- Do not locate the heater immediately below a socket outlet.
- This appliance can be used by children aged from 8 years and above and persons with reduced physical, sensory or mental capabilities or lack of experience and knowledge if they have been given supervision or instruction concerning use of the appliance in a safe way and understand the hazards involved. Children shall not play with the appliance. Cleaning and user maintenance shall not be made by children without supervision.
- Children of less than 3 years should be kept away unless continually supervised.
- Children aged from 3 years and less than 8 years shall only switch on/off the appliance provided that it has been placed or installed in its intended normal operating position and they have been given supervision or instruction concerning use of the appliance in a safe way and understand the hazards involved. Children aged from 3 years and less than 8 years shall not plug in, regulate and clean the appliance or perform user maintenance.
- **CAUTION - Some parts of the product can become very hot and cause burns. Particular attention has been given where children and vulnerable people are present.**
- Remove the plug from the mains socket (or disconnect pole switch) during installation, cleaning and/or replacing the emitter (lamp) and always ensure that the emitter (lamp) is cool.
- Do not use an extension cord with this product because the extension cord may overheat and cause a risk of fire.

WALL MOUNTED CONFIGURATIONS - AT A GLANCE

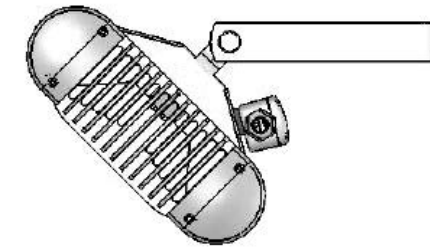

1 x Sorrento Double Unit

CHAIN HANGING CONFIGURATIONS - AT A GLANCE

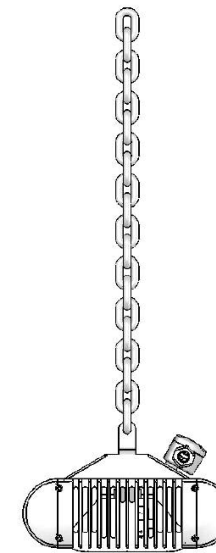

1 x Sorrento Double Unit

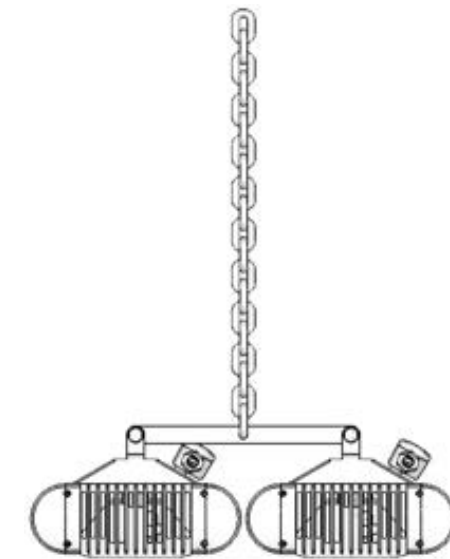

2 x Sorrento Double Units

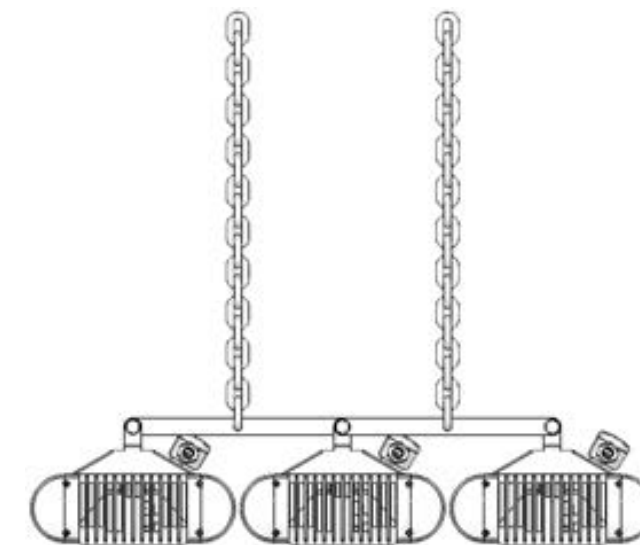

3 x Sorrento Double Units

PRODUCT GUARANTEE - PLEASE READ CAREFULLY

This product carries a full 24 month warranty from original date of purchase when used in accordance with these instructions. This excludes lamp emitter* when used in a commercial application which then carry a 30 day warranty from original date of purchase. This is subject to the heater being installed correctly. Should you be in any way uncertain, please call our CUSTOMER HELPLINE on +44 (0)121 580 6200 between 9.00am and 5.00pm (GMT) Monday to Friday. Please quote the serial number, model number, rating and date/place of purchase.

Should your product be faulty, please contact the distributor your purchased it from in the first instance.

Always retain your receipt as proof of purchase.

*(excludes breakages)

- Keep the mains supply cord away from the body of the heater which will get hot during use.
- Arrange the mains supply cord so it cannot be tripped over or damaged.
- Do not cover or obstruct the heater while it is in use.
- Do not insert any object through any slot or opening in the heater.
- Do not use if a guard is not present.
- Do not install less than the minimum mounting distance from the floor.
- **WARNING:** This heater should only be installed with an energy saving device to control the room temperature and operated by users capable of using the device. Do not use this heater in small rooms when they are occupied by persons not capable of leaving the room on their own, unless constant supervision is provided.
- Do not touch the heater when it is turned on, as the body gets hot.
- Do not use the heater in a bathroom, laundry areas and similar locations. Never locate the heater where it may fall into a bathtub or other water container.
- A heater has hot parts inside. Do not use it in areas where petrol, paint, or flammable liquids are used or stored.
- If the supply cord becomes damaged, it must be replaced by the manufacturer, its service agent or a similar qualified person in order to avoid a hazard.
- **WARNING:** This appliance must be connected to a supply that is earthed! 

**IMPORTANT -
SAVE THESE INSTRUCTIONS FOR FUTURE REFERENCE**

	WARNING: RISK OF FIRE	
Keep combustible material such as furniture, papers, clothes and curtains at least 1.8m (6ft) away from the sides and rear.		

INTRODUCTION

The Sorrento IP Double heater produces radiant heat like the sun, warming people and objects rather than the air in between. It is mounted on an adjustable bracket that allows the heat to be directed exactly where it is required. Its attractive, lightweight design means that it is effective yet unobtrusive. The Sorrento IP Double heater is weatherproof so is suitable for outdoor use or can be used indoors in conjunction of a suitable energy saving control device (contact Tansun for details).

Please read the following instructions carefully before use. The safety of this heater is guaranteed only by its correct usage in accordance with these instructions, therefore it is recommended that they are retained for future reference.

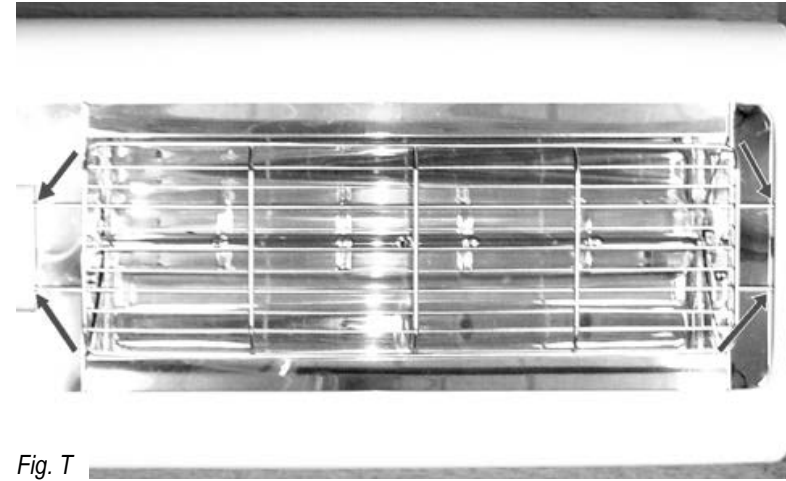

Fig. T

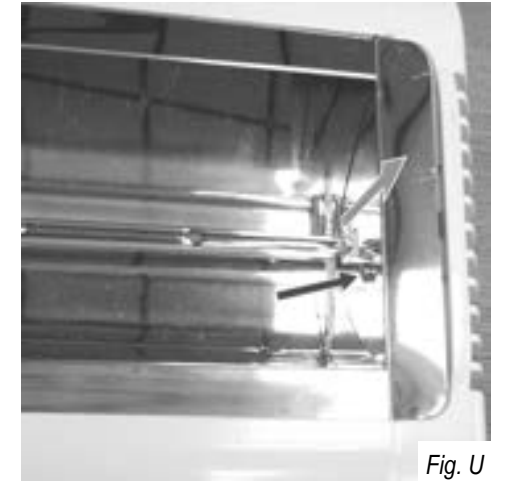

Fig. U

7. Remove the screw (Fig. U) from the side reflector and lift it up away from the heater to remove it. Repeat at opposite end to remove other side reflector.

8. The lamp emitter wires should be pulled out of the side slots and the lamp emitter can be lifted up completely (Fig. V). The wires should be gently pulled so they come out from behind the reflector.

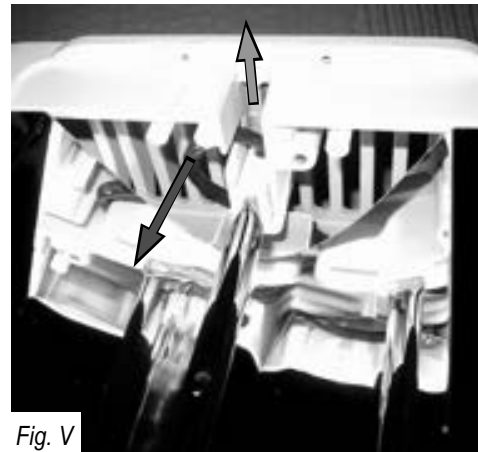

Fig. V

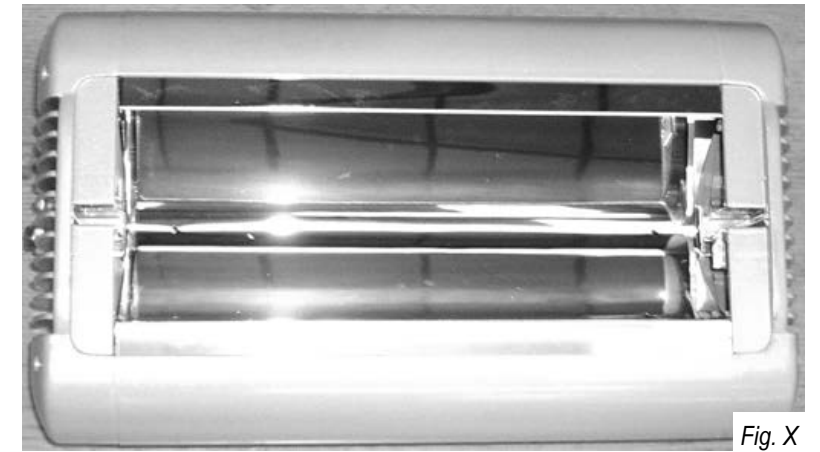

Fig. X

9. The lamp emitter should now be removed from the heater as shown in Fig. X.

10. Refit the new lamp emitter in reverse order ensuring that no wires get trapped and all screws are fully tightened.

SPECIFICATION

Table 1. UK and European Double Heaters

No. of Units x Model Type	Voltage (Volts)	No. of Lamp Emitters x Power (Watts)	Total Power (Watts)	Current (A) Per Lamp Emitter	Total Current (A) of unit	Min. height from floor (m)	Min. dist. from ceiling (m)	Min. dist. from side wall (m)	Dimensions (inc. bracket & bars max. pos.) W x H x D (mm)	Weight (kg)	Ingress Protection (IP)
1 x SOR 210IPD	230	2 x 1000	2000	4.3	8.7	2.5	0.5	1.0	790 x 227 x 323	5.6	IP55
1 x SOR 215IPD	230	2 x 1500	3000	6.5	13.0	3.0	0.5	1.0	790 x 227 x 323	5.6	IP55
1 x SOR 220IPD	230	2 x 2000	4000	8.7	17.4	3.5	0.5	1.0	790 x 227 x 323	5.6	IP55
2 x SOR 210IPD	230	4 x 1000	4000	4.3	17.4	3.5	0.5	1.0	790 x 460 x 142	11.2	IP55
2 x SOR 215IPD	230	4 x 1500	6000	6.5	26.1	4.5	0.5	1.5	790 x 460 x 142	11.2	IP55
2 x SOR 220IPD	230	4 x 2000	8000	8.7	34.8	4.7	0.5	1.5	790 x 460 x 142	11.2	IP55
3 x SOR 210IPD	230	6 x 1000	6000	4.3	26.1	4.5	0.5	1.5	790 x 693 x 142	16.8	IP55
3 x SOR 215IPD	230	6 x 1500	9000	6.5	39.1	5.0	0.5	1.5	790 x 693 x 142	16.8	IP55
3 x SOR 220IPD	230	6 x 2000	12000	8.7	52.2	5.0	0.5	1.5	790 x 693 x 142	16.8	IP55

Note: Use MCB Type 3 or Type C.

REPLACING A LAMP EMITTER

CAUTION

If you are in any doubt about following the procedure below, please contact us for technical assistance. The mains power should be disconnected before any attempts are made to replace a lamp emitter. The following should be carried out with compliance to the latest electrical regulations. If you are unfamiliar with installing such fixtures, contact a qualified electrician to carry out.

1. Ensure the heater and lamp emitter are cool and the power supply is disconnected by removing the plugs from the socket outlet - all plugs must be removed even if only one emitter is to be replaced or disconnect large pole switch(es).

2. Remove the screws from the terminal box at the back of the emitter you wish to replace and lift off the lid - see Fig. P.



Fig. P

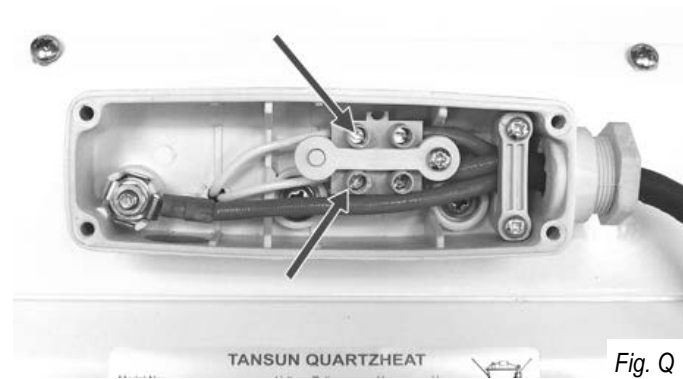

Fig. Q

3. Disconnect the lamp emitter from the connector blocks by unscrewing the screws highlighted above in Fig. Q and remove the lamp emitter wires from the terminal block.

4. At the back of the heater, remove the plate holding the terminal box by removing the two fixing screws as shown in Fig. R.

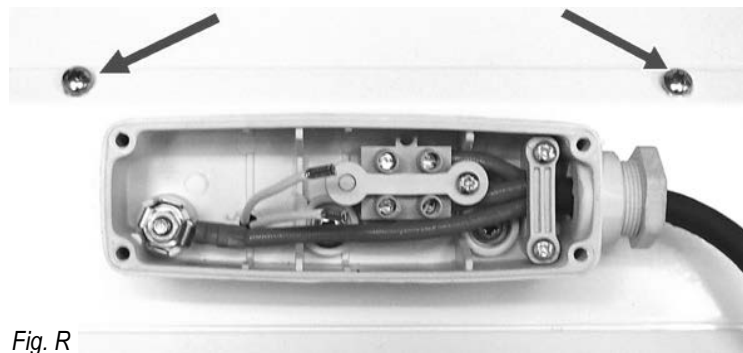

Fig. R

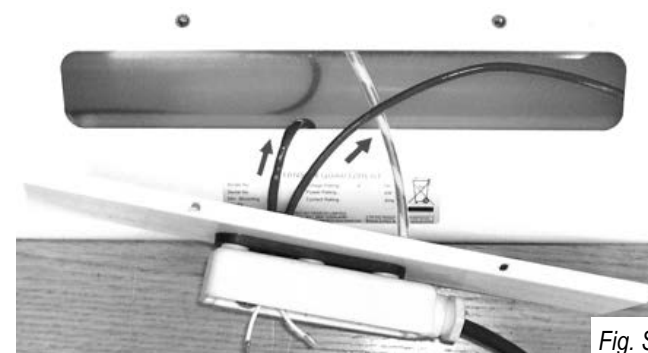

Fig. S

5. Pull the lamp emitter wires one at a time through the plate to remove as shown in Fig. S.

6. At the front of the heater, the guard in front of the lamp emitter should be removed by gently pulling it away from the heater so it prises out of its locating holes at each end (Fig. T).

CONFIGURATIONS

The Sorrento IP Double heater is a single unit that contains 2 x lamp emitters. It can be installed as an individual unit or joined to one or two more units (totalling three for chain hanging only) using short or long joining bars (available as an accessory separately) to increase the size and output of the installation. Please read the section 'joining individual heaters together' for information on how this should be done.

INSTALLATION - ALL CONFIGURATIONS

- Warning - this appliance must be connected to an earthed supply.
- The wired versions (020IP-UK, 020IP-EU, 030IP-UK, 030IP-EU, 040IP-UK & 040IP-EU) are fitted with 2 x supply cables 3.0 metres long with moulded plugs, therefore it is unnecessary to remove the terminal box in order to carry out normal installation of these models.
- All unwired versions (020IP-SW, 030IP-SW & 040IP-SW) should be installed by a suitably qualified electrician, following the instructions below.
- All installations must be in accordance with the latest electrical safety regulations.
- We recommend using a RCD where applicable.
- If self wiring, a large double pole switch with a 3.0mm contact disconnection should be fitted.
- Please observe the minimum safe distance between the heater body and any inflammable surfaces.
- When the electrical connection is outside, it is recommended that a waterproof socket is used for the connection/terminal. Otherwise, the plug should be connected to a socket indoors.
- When installing indoors the heater should be connected to a suitable energy saving controller (please contact Tansun for details).
- If in any doubt, please contact a suitably qualified electrician.

1. Unscrew the terminal box cover at the back of the heater and feed the supply cable through the compression gland ensuring the rubber seal is on the cable.

2. Use a minimum of 1.0mm² H05RN-F supply cable with 2 poles and earth and sleeve with silicon glass fibre braided (250°C) Sleeving. The live and neutral wires must be connected to the terminal block. See Fig 1.

3. The green/yellow wire should be connected to the clamp marked with the earth symbol using a suitable wire terminal. Fit cord grip and terminal box saddle once wired.

4. Tighten the barrel nut of the compression gland so that the rubber seal grips the cable (Fig 2).

5. To prevent water ingress, ensure that the cover is secured well by hand tightening all for screws evenly.

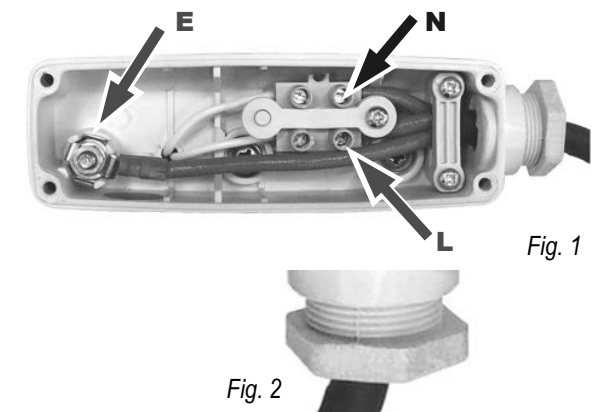

Fig. 1

Fig. 2

continued...

MOUNTING - INDIVIDUAL UNIT (WALL MOUNTING OR CHAIN HANGING)

- The Sorrento IP Double heater should only be wall mounted in a horizontal manner or hung from a ceiling from chains (not supplied).
- When wall mounting the Sorrento IP Double heater in a horizontal manner, do not position the heater at an angle more than 90° and less than 30° as shown in Fig. A.
- When ceiling hanging the Sorrento IP Double heater, ensure the minimum distance from the ceiling is adhered to as shown in Fig. B.
- Always allow the heater to cool before attempting to reposition/move. Never attempt to move the heater while it is switched on!
- Observe the minimum safe distance between the heater body and inflammable surfaces and objects when mounting.
- Please refer to Table 1 for the recommended positioning of the heater with regards to minimum distances. Do not install the heater in a corner!
- Keep out of the reach of children.

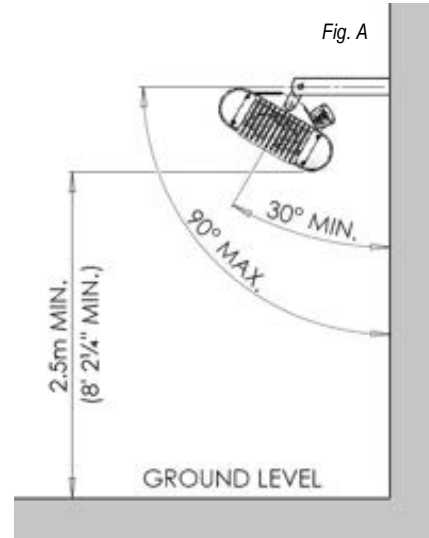

1. When wall mounting, securely fasten the L-shaped wall brackets to the mounting surface using both of the fixing holes in the short part of the bracket (see Fig. D for mounting hole centres). Please refer to Table 1 for recommended positioning of the heater. Please note. Wall fixings are not supplied. They should be selected to substantially support the weight of the installation. If in doubt contact a professional for advice! When hanging from a ceiling two equal length and gauge chains are required and should be selected with fixings that are more than adequate to hold the weight of the heater. Again, if in doubt contact a professional for advice!

2. The heater should be mounted with the terminal box at the bottom of the heater when being wall mounted.

3. When wall mounting, fix in the required angular position by tightening the fixing bolts on the brackets at the rear of the heater as shown in Fig. C. The heater should face directly down when hanging.

4. Secure the supply cable so it is not resting on the body or obstructing the air-vents.

Always isolate the heater from the mains supply when adjusting the position.

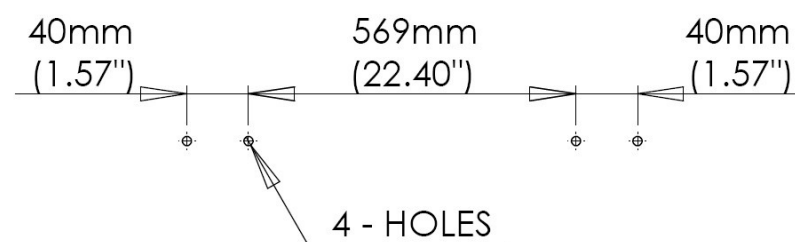
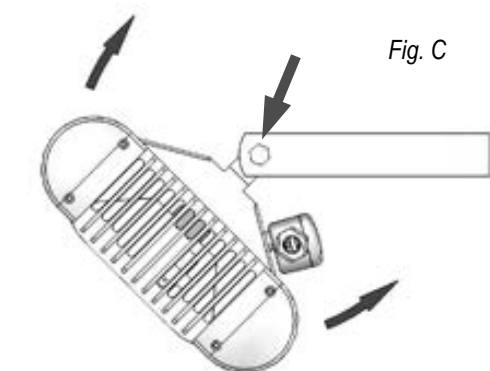
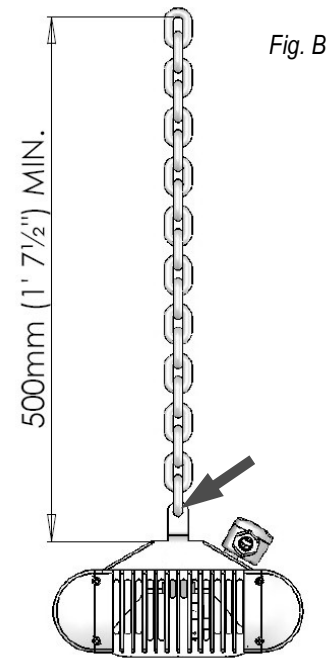

MAINTENANCE

In the event of heater failure, or for spare parts or advice, please contact the manufacturer in the first instance.

- Disconnect from the mains before commencing any maintenance procedure including cleaning.
- To ensure optimum heat effectiveness, it is recommended that the guard is removed and the reflector is wiped with a lint-free cloth should the reflector show considerable signs of dust or dirt.

YOUR REPLACEMENT LAMP EMITTER

It is very important that your replacement lamp emitter is exactly the same as the one it was supplied with. Failure to fit the exact same type could cause the heater to fail or even become dangerous especially when used in an outdoor environment.

Please contact Tansun Limited to purchase your replacement lamp emitter and state the model number of the heater you wish to fit the lamp emitter to.

HANDLING THE REPLACEMENT LAMP EMITTER

Your new lamp emitter should not be handled with bare hands.

Remove finger marks with a soft cloth and methylated spirits or rubbing alcohol. Finger marks will burn into the quartz glass causing it to fail prematurely.



ASSEMBLING - THREE INDIVIDUAL HEATERS JOINED

1. Take the first heater and lie it face down on a flat surface.
2. Take the second and third heaters and position them face down and parallel to the first.
3. Push the M8 bolts (used to hold the wall brackets through the hole in the brackets on the rear heaters and slide a shake-proof washer on all the threads from the protruding side.
4. Slide the long joining bar (not supplied, available separately) on each bolt and fit a washer and nut – do not fully tighten at this point.
5. Position the second heater so it's parallel to the first and sitting flat.
6. Take the third heater and a long joining bar. Push a bolt and washer through the end hole and place a serrated washer on the other side. Push the bolt through the bracket hole on heater. Repeat on opposite side and secure with a washer and nut – do not fully tighten at this point.
7. Position the third heater so it's parallel to the second.
8. Line-up the bars of the first heater with the brackets of the second heater – they should go on the inside faces like heater one.
9. Line-up the bars of the third heater with the brackets of the second heater – these should go on the outside faces like heater three.
10. Push a bolt from the back of the long joining bars through the holes putting a serrated washer on each side of the heater bracket.
11. Fit a washer and nut to both sides and providing the assembly is sitting flat, fully tighten both sides and also the nuts of the first and third heaters to the long joining bars.
12. The heater is now ready for mounting or hanging.

CEILING HANGING - THREE INDIVIDUAL HEATERS JOINED

- When three Sorrento IP heaters are joined they can be hung from a ceiling from chains.
 - Always allow the heater to cool before attempting to reposition/move. Never attempt to move the heater while it is switched on!
 - Observe the minimum safe distance between the heater body and inflammable surfaces and objects when mounting.
 - Please refer to Table 1 for the recommended positioning of the heater with regards to minimum distances. Do not install the heater in a corner!
 - Keep out of the reach of children.
1. Please refer to Table 1 for recommended positioning of the heater. When hanging from a ceiling four chains of equal length and gauge are required and should be selected with fixings that are more than adequate to hold the weight of the heater. If in doubt contact a professional for advice!
 2. Fix the heater assembly to the chains via the hole in the centre of the joining bars as shown in Fig. N. and ensure the heater faces directly down when hanging.
 3. Secure the supply cable so it is not resting on the body or obstructing the air-vents.

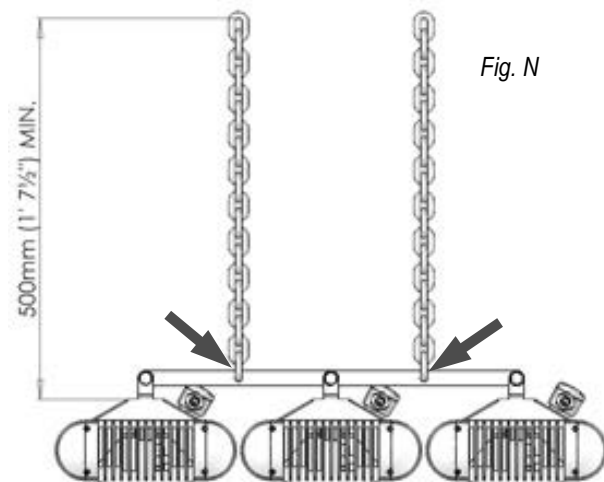

Always isolate the heater from the mains supply when adjusting the position.

JOINING INDIVIDUAL HEATERS TOGETHER

The Sorrento IP Double heater can be joined to other Sorrento IP Double heaters using the joining bars which are available as an optional accessory. A maximum of three individual heaters can be joined in one installation.

ASSEMBLING - TWO INDIVIDUAL HEATERS JOINED

1. Take the first heater and place it face down on a flat surface.
2. Take the second heater and place it face down and positioned parallel to the first heater.
3. Push the M8 bolts (used to hold the wall brackets through the hole in the brackets on the rear heaters and slide a shake-proof washer on all the threads from the protruding side.
4. Slide the joining bars on each bolt and fit a washer and nut – do not fully tighten at this point.
5. Ensure the second heater is still parallel to the first and sitting flat.
6. Slide the joining bars on each protruding bolt of the other heater to connect them together and fit the washers and nuts.
7. Again, ensuring the heaters remain flat, fully tighten all four nuts to secure the joining bars in place.

CEILING HANGING - TWO INDIVIDUAL HEATERS JOINED

- When two Sorrento IP Double heaters are joined they should only be hung from a ceiling on chains - do not wall mount!
 - Always allow the heater to cool before attempting to reposition/move. Never attempt to move the heater while it is switched on!
 - Observe the minimum safe distance between the heater body and inflammable surfaces and objects when mounting.
 - Please refer to Table 1 for the recommended positioning of the heater with regards to minimum distances. Do not install the heater in a corner!
 - Keep out of the reach of children.
1. Please refer to Table 1 for recommended positioning of the heater. When hanging from a ceiling two chains of equal length and gauge are required and should be selected with fixings that are more than adequate to hold the weight of the heater. If in doubt contact a professional for advice!
 2. Fix the heater assembly to the chains via the hole in the centre of the joining bar as shown in Fig. E. and ensure the heater faces directly down when hanging.
 3. Secure the supply cable so it is not resting on the body or obstructing the air-vents.

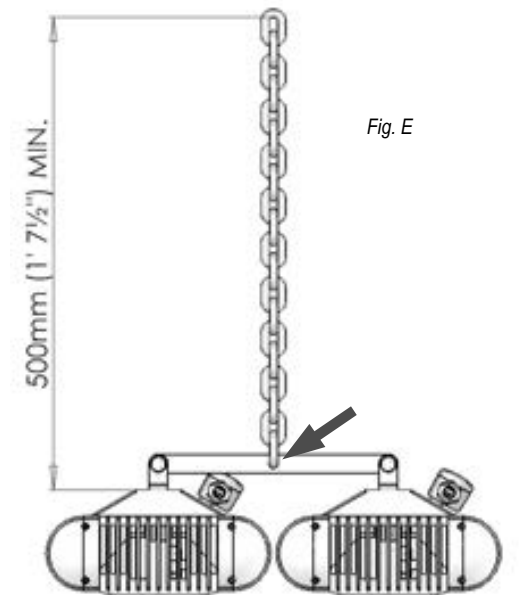

Always isolate the heater from the mains supply when adjusting the position.