

11. The lamp is held in at each end by spring clips that hold the lamps ceramic caps in the lamp holders. Pull the clips back (Fig. 11a) far enough to allow the ceramic caps to be lifted up (Fig. 11b) at both ends and remove the lamp from the heater.

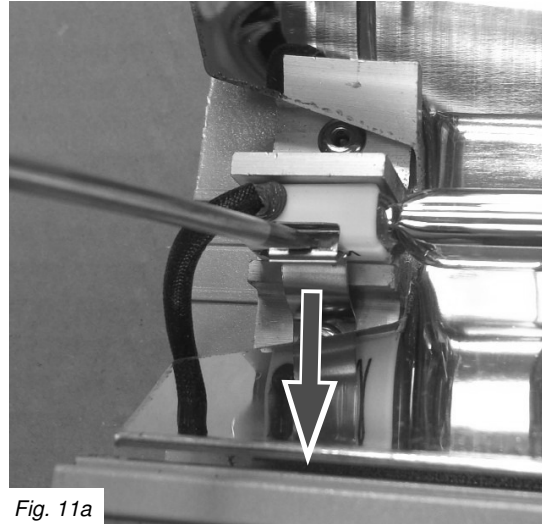

Fig. 11a

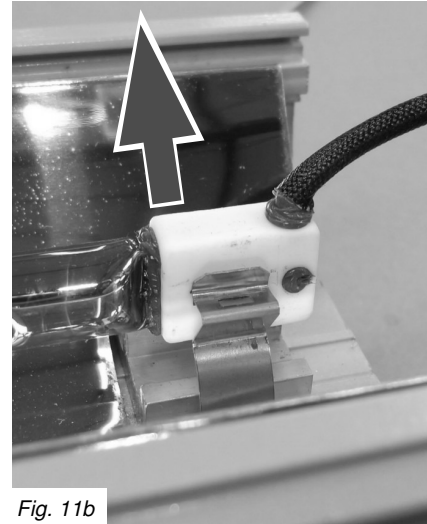

Fig. 11b

12. The heater should now be broken down as shown in Fig. 12. Note: One of the lamp wires is longer than the other. Ensure your new lamp wires are the same length and it's fitted the same way around as the original.

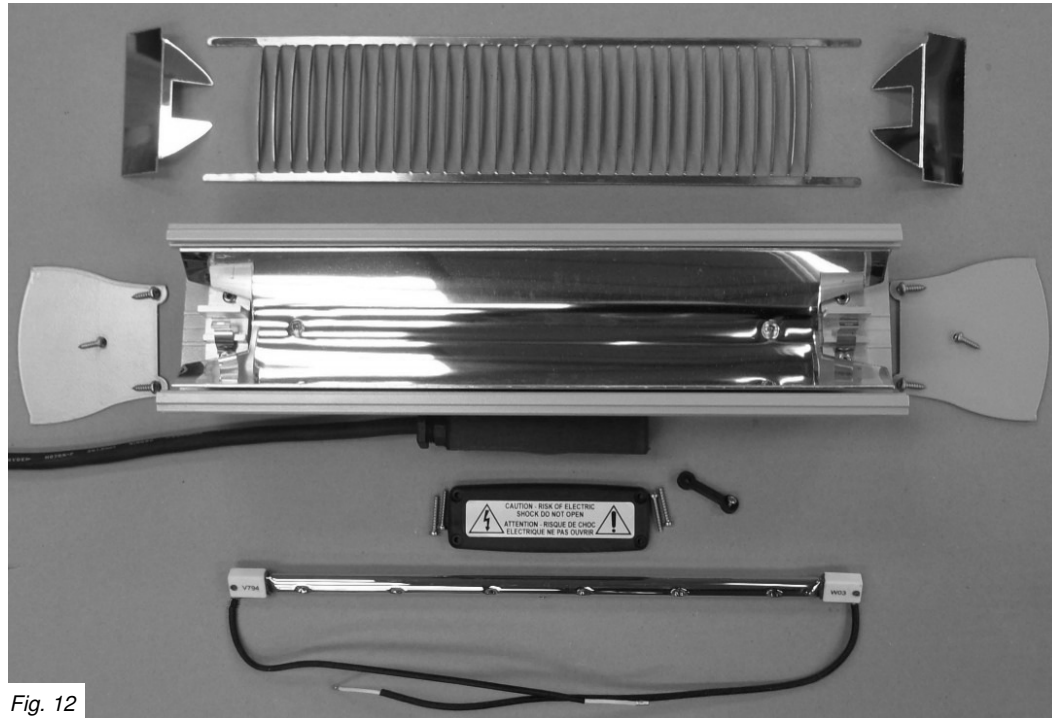

Fig. 12

13. Refit the new lamp in reverse order ensuring that no wires get trapped and all screws are fully tightened.

Following information is only for EU-member states:

The use of this symbol indicates that this product may not be treated as household waste. By ensuring this product is disposed of correctly, you will help prevent potential negative consequences for the environment and human health, which could otherwise be caused by inappropriate waste handling of this product. For more detailed information about recycling of this product, please contact your local council, your household waste disposal service or the shop where you purchased the product.



Reference Manual

Algarve

UK & EUROPEAN MODELS:

ALG 510 UK & ALG 510 EU	(230 V - 1000 W)
ALG 513 UK & ALG 513 EU	(230 V - 1300 W)
ALG 515 UK & ALG 515 EU	(230 V - 1500 W)

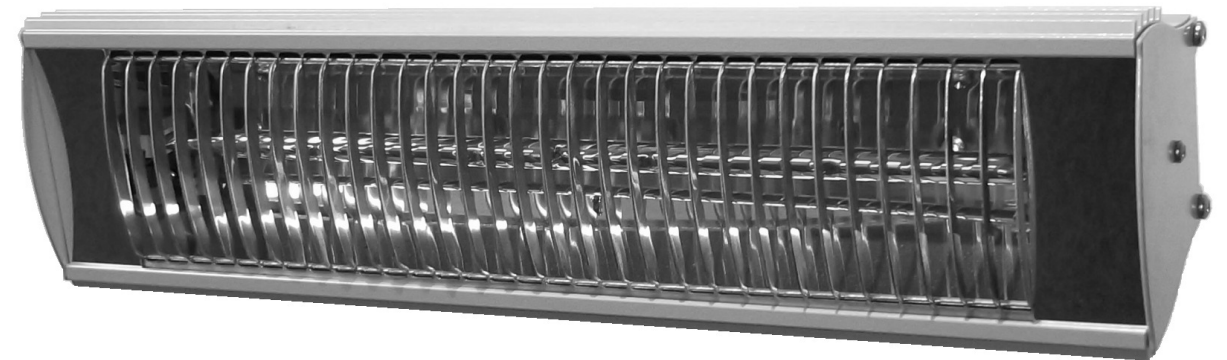

TANSUN LIMITED

Spectrum House, Unit 1, Ridgacre Road, West Bromwich,
West Midlands, B71 1BW, England.

Tel: +44 (0)121 580 6200 - Fax: +44 (0)121 580 6222
Email: sales@tansun.com - Website: www.tansun.com

Caution

When using Tansun electrical heaters, basic precautions should always be followed to reduce the risk of fire, electric shock, and injury to persons, including the following:

Read all instructions before using this heater.

- Before using this appliance:
 - Check that the voltage indicated on the type plate corresponds to the mains supply voltage.
 - Ensure that the heater has been securely fastened in its final mounting position.
- Do not locate the heater immediately below a socket outlet.
- This appliance can be used by children aged from 8 years and above and persons with reduced physical, sensory or mental capabilities or lack of experience and knowledge if they have been given supervision or instruction concerning use of the appliance in a safe way and understand the hazards involved. Children shall not play with the appliance. Cleaning and user maintenance shall not be made by children without supervision.
- Children of less than 3 years should be kept away unless continually supervised.
- Children aged from 3 years and less than 8 years shall only switch on/off the appliance provided that it has been placed or installed in its intended normal operating position and they have been given supervision or instruction concerning use of the appliance in a safe way and understand the hazards involved. Children aged from 3 years and less than 8 years shall not plug in, regulate and clean the appliance or perform user maintenance.
- **CAUTION—Some parts of the product can become very hot and cause burns. Particular attention has been given where children and vulnerable people are present.**
- Remove the plug from the mains socket (or disconnect pole switch) during installation, cleaning and/or replacing the element and always ensure that the element is cool.

7. Remove the connector block retaining bridge by removing the screw and lifting out. This will allow the connector block to be lifted out of its locating lugs to allow for better access when connecting the new lamp terminals. For now though leave it in its locating lugs and unscrew the connector block screws as highlighted (Fig. 7a) and remove the white lamp wires so they are free (Fig. 7b).

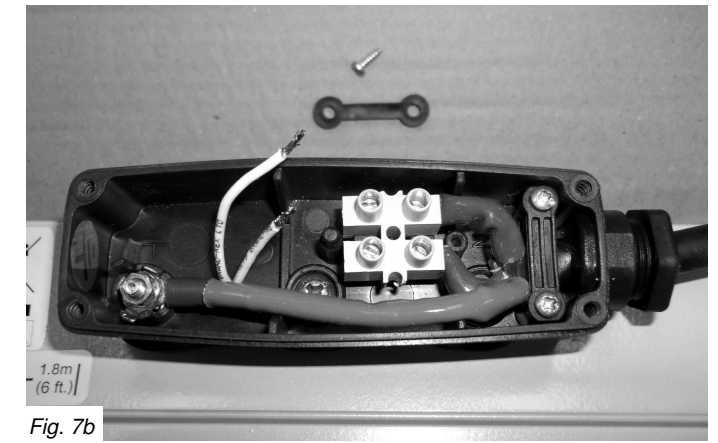
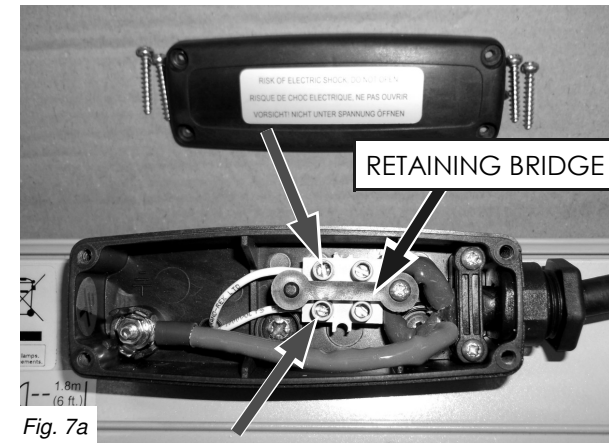

8. From inside the heater body, gently pull the lamp wires through the sealing gasket so the lamp wires exit the terminal box and are free as shown below in Fig. 8.

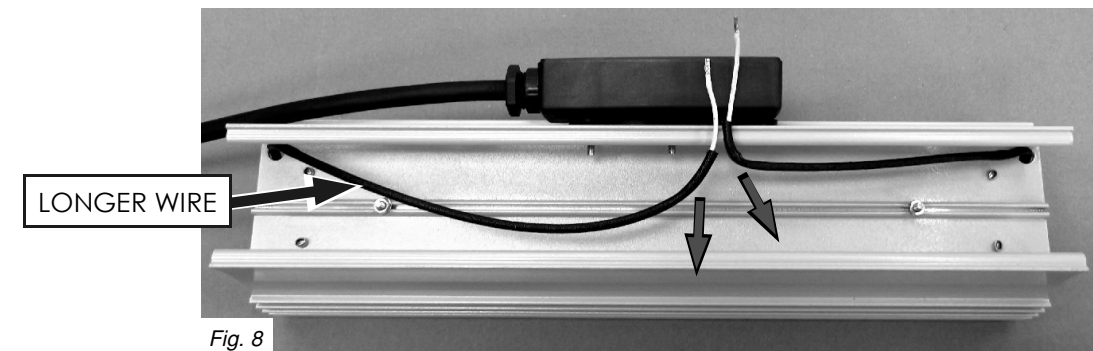

9. Turn the heater body over and slide the side reflectors out at each end and then slide the guard out of the heater by pushing it towards one of the ends where the end caps are removed (Fig. 8). Note: the reflectors sit on top of the guard legs for refitting.

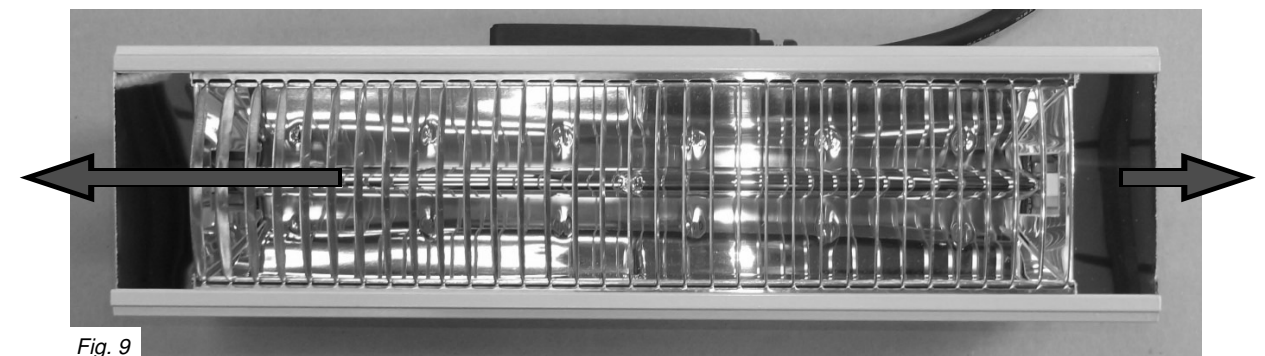

10. Pull the lamp wires through the two access holes so it is ready to be unclipped and removed from the heater (Fig. 10).



Replacing the Lamp

If you are in any doubt about following the procedure below, please contact us for technical assistance. The mains power should be disconnected before any attempts are made to replace the lamp. The following should be carried out with compliance to I.E.E. regulations. Please read the notes above with regards to handling and buying a replacement lamp before proceeding.

1. Ensure the heater and lamp are cool and the power supply is disconnected by removing the plug from the socket outlet as shown in Fig. 1.

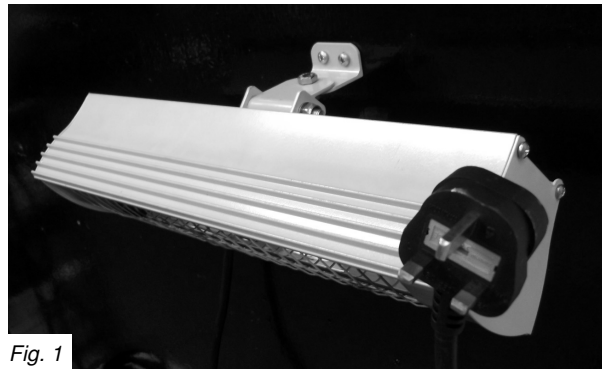

Fig. 1

2. Remove one of the heater end caps by removing the three screws with a pozi-head screwdriver as shown in Fig. 2.

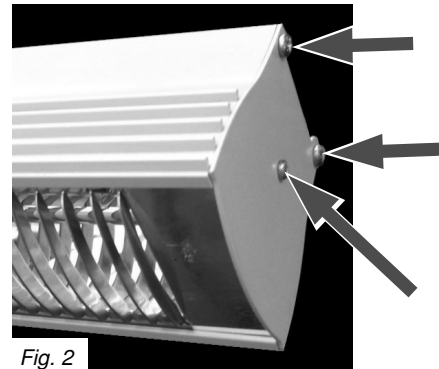

Fig. 2

3. The heater will now be free to slide off the back plate (Fig. 3a). Gently slide the heater body away from the open end as shown in Fig. 3b ensuring not to drop it as it comes from its mounting.



Fig. 3a

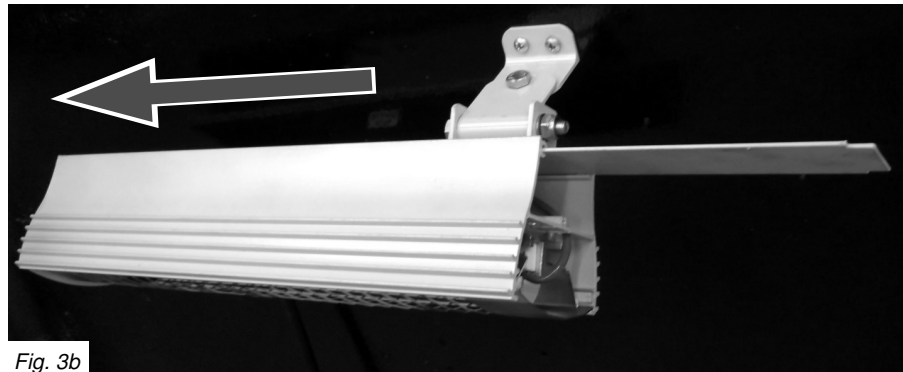

Fig. 3b

4. The back plate should now have the heater body removed from it (Fig. 4) and can be placed on a safe, flat work surface to proceed with the lamp change.

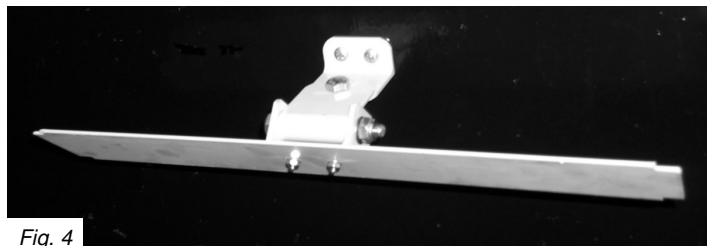

Fig. 4

5. Stand the heater on its open end and remove the other end cap (Fig. 5).

6. Remove the four screws (Fig. 6) from the terminal box and lift off the lid.

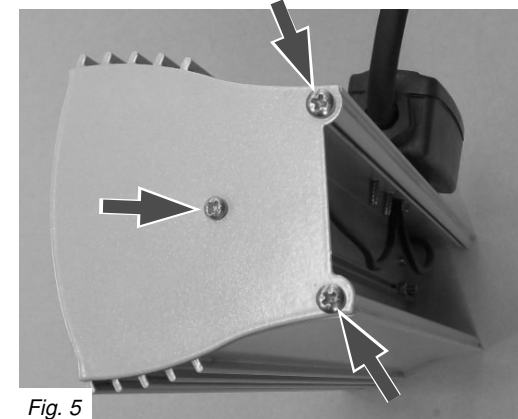

Fig. 5



Fig. 6

- Do not use an extension cord with this product because the extension cord may overheat and cause a risk of fire.
- Keep the mains supply cord away from the body of the heater which will get hot during use.
- Arrange the mains supply cord so it cannot be tripped over or damaged.
- Do not cover or obstruct the heater while it is in use.
- Do not insert any object through any slot or opening in the heater.
- Do not use if a guard is not present.
- Do not install less than the minimum mounting distance from the floor.
- **WARNING:** This heater is not equipped with a device to control the room temperature. Do not use this heater in small rooms when they are occupied by persons not capable of leaving the room on their own, unless constant supervision is provided.
- Do not use the heater in a bathroom, laundry areas and similar locations. Never locate the heater where it may fall into a bathtub or other water container.
- A heater has hot parts inside. Do not use it in areas where petrol, paint, or flammable liquids are used or stored.
- **WARNING:** This appliance must be connected to a supply that is earthed! ⚡

**IMPORTANT -
SAVE THESE INSTRUCTIONS FOR FUTURE REFERENCE**

Risk of Fire

Keep combustible materials such as furniture, papers, clothes and curtains at least 1.8m (6 feet) from the front of the heater and away from the sides and rear. If the heater is to be used outside, we recommend that a waterproof or indoor socket outlet is used.

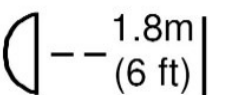

Introduction

The Algarve heater produces radiant heat like the sun, warming people and objects and not the air in between, providing the only form of heat that will not blow out or away. The heaters are mounted on adjustable brackets that allows the heat to be directed exactly where it is required. Its attractive design means that it is effective yet unobtrusive. The Algarve heater is designed for indoor and outdoor use and is therefore weatherproof.

Please read the caution notes and following instructions carefully before use. The safety of this heater is guaranteed only by its correct usage in accordance with these instructions, therefore it is recommended that they are retained for future reference.

Specification

Table 1. UK and European Heaters

Model	Voltage (V)	Total Power (W)	Current (A)	Min height from floor (cm)	Min distance from ceiling (cm)	Min distance from side wall (cm)	Dimensions W x H x D (cm)	Weight (kg)	Ingress Protection (IP)
ALG 510	230	1000	4.3	200	30	100	39 x 10 x 11	2.4	IPX5
ALG 513		1300	5.7						IP55
ALG 515		1500	6.5						

Use an MCB Type 3 or C.

Installation

- Warning - this appliance must be connected to an earthed supply. 
- The heater is fitted with 3.0 metres of mains supply cord and a moulded plug, therefore it is unnecessary to remove the terminal box in order to carry out normal installation of this model.
- All installations must be in accordance with the latest I.E.E. safety regulations or equivalent.
- We recommend using a RCD where applicable.
- If the supply cord becomes damaged, it must be replaced by the manufacturer, its service agent or a similar qualified person in order to avoid a hazard.
- Please observe the minimum safe distance between the heater body and any inflammable surfaces.
- If in any doubt, please contact a suitably qualified electrician.
- To disconnect heater, remove the mains plug from the socket outlet.

Mounting

- The heater can be mounted in a horizontal (Fig. A) or angled (Fig. D) manner.
- When mounting the heater horizontally, do not position the heater at an angle more than 90° and less than 45° from the vertical mounting surface as shown in Fig. A. Ensure the terminal box is on the underside of the heater when mounting.
- When angled mounting the heater, ensure to leave a gap between the heater and mounting surface (See Fig. D - DIM 'A'). The heater should always be angled downwards when mounting this way with the cord from the terminal box at the bottom of the heater - see Fig. D. Do not position the heater at an angle more than 45° and less than 30° to the horizontal as shown.
- Always allow the heater to cool before attempting to reposition/move. Never attempt to move the heater while it is switched on!
- Observe the minimum safe distance between the heater body and inflammable surfaces and objects when mounting.
- Please refer to Table 1 for the recommended positioning of the heater.
- Keep out of the reach of children.

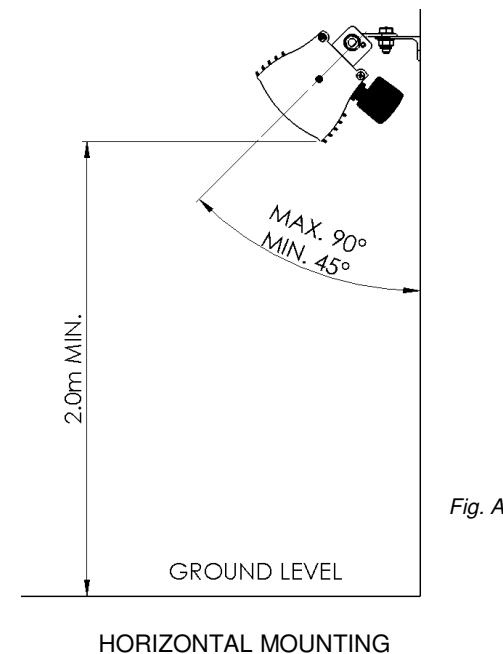

Mounting continued...

- Securely fasten the L-shaped heater bracket to the mounting surface using the fixing holes in the bracket. Please refer to Table 1 for recommended positioning of the heater.
- Fix in the required angular position by tightening the fixing bolt on the bracket at the rear of the heater.
- The heater bracket assembly can be used to adjust the direction of the heater up and down (see Fig. B) and side to side (see Fig. C). This is done by loosening the bolts fixing the heater to the bracket, and then retightening once the correct position is achieved.

Always isolate the heater from the mains supply when adjusting the angular position.

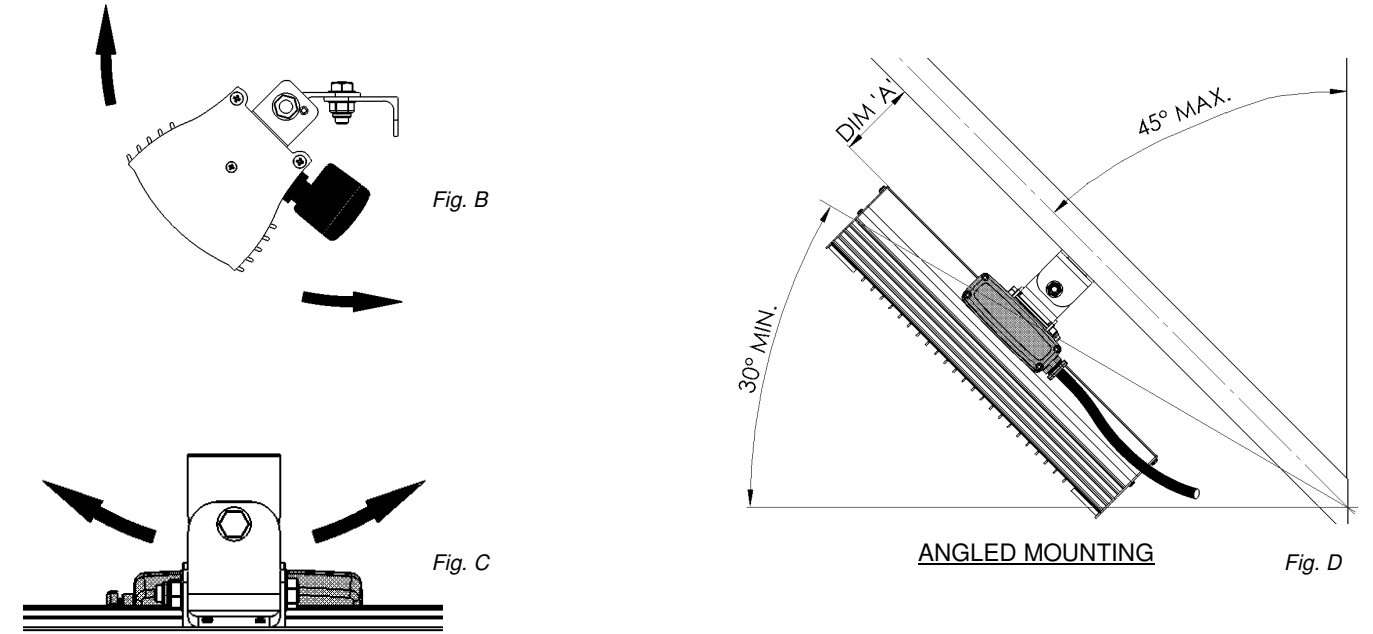

Maintenance

In the event of heater failure please contact the retailer or seller in the first instance. For spare parts or advice, please contact Tansun Limited.

- Disconnect from the power supply by removing the plug from the mains socket before commencing any maintenance procedure including cleaning.
- To ensure optimum heat effectiveness, it is recommended that the reflector is kept clean. If dirt appears to build up on the reflector, the front safety guard should be removed and the reflector wiped with a lint-free cloth before re-fitting.
- The heater is supplied with a safety guard. In the unlikely event that this gets damaged, please contact Tansun Limited for an immediate replacement.

Your Replacement Lamp

It is important that your replacement lamp is exactly the same as the one it was supplied with. Failure to fit the exact same type could cause the heater to fail or even become dangerous. Please contact Tansun Limited or your service agent to purchase your replacement lamp and state the model number of the heater you wish to fit the lamp to.



Handling the Replacement Lamp

Your new lamp should not be handled with bare hands. Remove finger marks with a soft cloth and methylated spirits or rubbing alcohol. Finger marks will burn into the lamps quartz glass causing premature failure.

